



SPX1275CDH



	5730 x 1450 x 2040 mm		
	4600 x 4600 mm		
	kg		
	SPX1275	6800	
	/	1500	
	8T-D10	60	
	PP400-8D PP220-8D	105	
	JIB60002H	220	
	JIB10001FL	310	
	ISUZU 3CE1		
	3	kW	26,9kW 36,0Hp

4,9-17,7 m 65 sec.

360° 1,0 rpm



-4°/75° 40 sec.

MAX
6800 kg

	0,72 Kg/cm ²		1,6/3,1 Km/h
	20°		1450-2050 mm

AUX
8 kW - 3F
400 VAC 50 Hz
8 kW - 1F
220 VAC 60 Hz

	1500 kg 125 m - Ø 10 mm 30-55 m/min
	7500 5 -23 m
	6000 4 -29 m
	4500 3 -37 m
	3000 2 -52 m
	1500 1 -116 m

	7500 Kg
	16,2 m
	26,7 m

- DTC**
- LMI** **P&C**
- CCI** **VW**
- GSC** **2WR**
- A2B** **2SW**

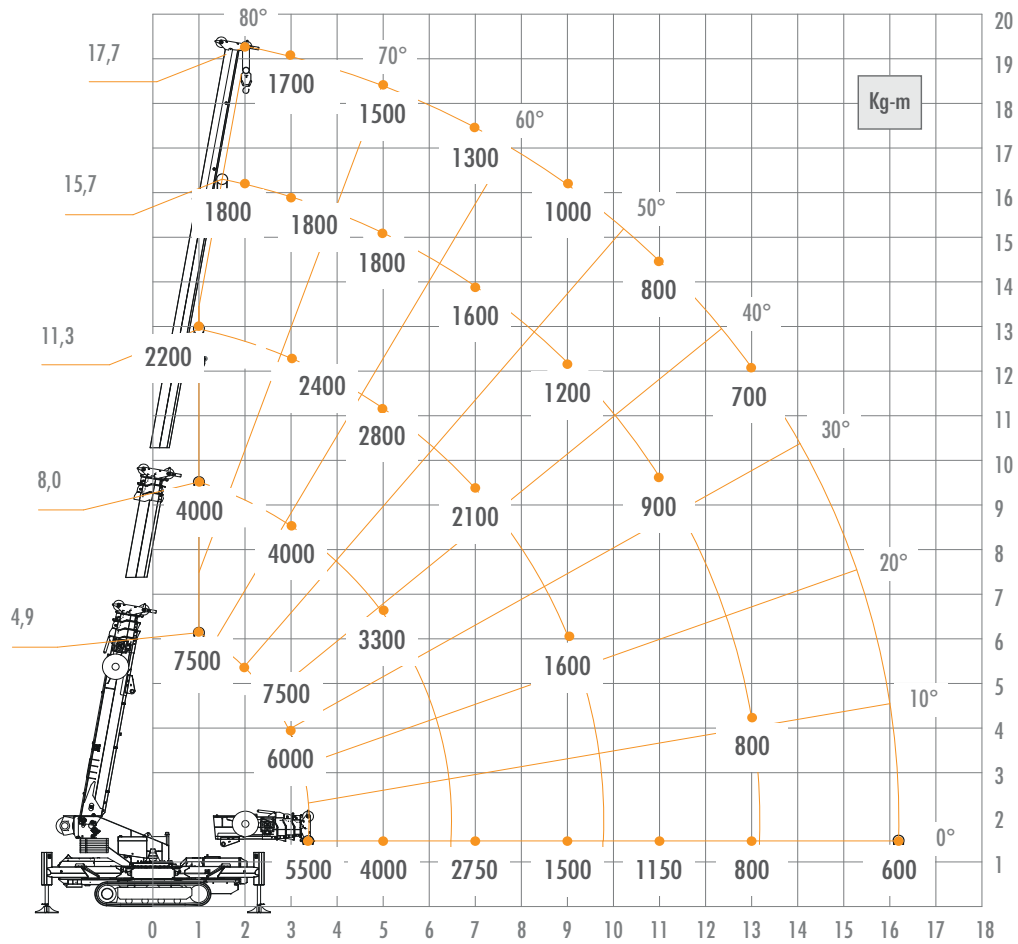

JIB600.2H | **JIB1500.1FL**

MAX 600 Kg

MAX 1500 Kg



MAX	24,5 m
MAX	500 kg



MAX	26,7 m
MAX	900 kg

MAX	16,2 m
MAX	400 kg

MAX	16,0 m
MAX	200 kg

